

SERIES 4070-T: ARCHE-DUCT DRAIN OPTIONS

U:\Cadfiles_Admin\Products\4070-T\Sales_Docs

COMPANY:

QUOTE #:

ITEM #:

DATE:

DRAIN COUPLINGS TO BE WELDED PER OPTION

PLEASE MAKE SELECTIONS:

>> 1) DRAIN SPACING

(A) 1) 1" NPT DEFAULT: 8" FROM END; 60" MAX.....
(O.C.)

2) 1/2" NPT DEFAULT: 8" FROM END; 60" MAX....
(O.C.)

(B) OTHER.....

1) FROM END (O.C.):.....

2) SPACING (O.C.):.....

(C) CUSTOM DRAWING:.....

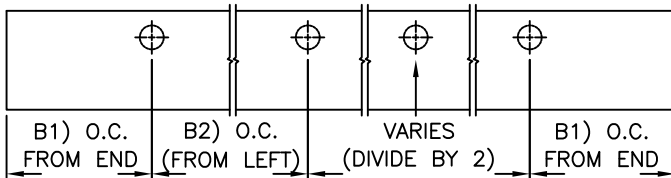
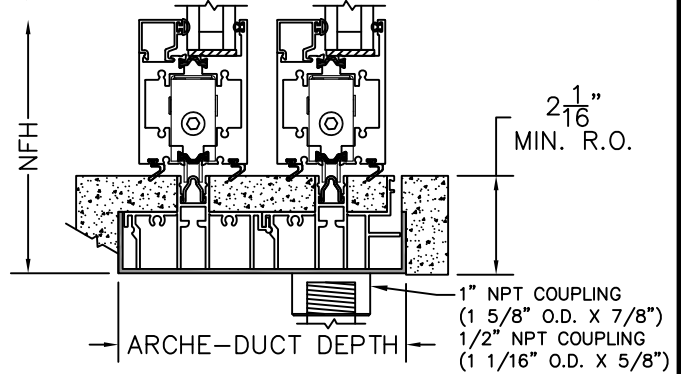
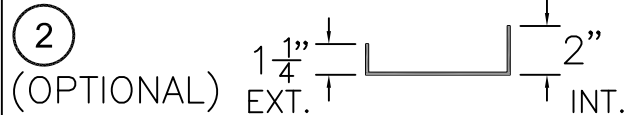
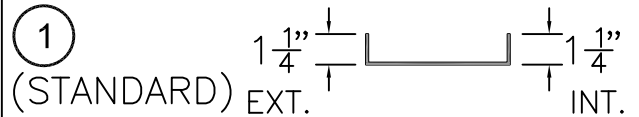

ILLUSTRATION ONLY
(TWO TRACK 1" BOTTOM DRAIN SHOWN)



>> ARCHE-DUCT HEIGHT <<



>> 2) DRAIN COUPLING LOCATIONS (OPTIONS)

< BOTTOM DRAINS >

(A) (INTERIOR).....

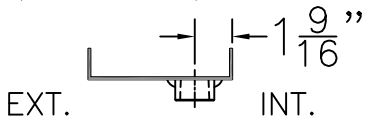

(B) (EXTERIOR).....

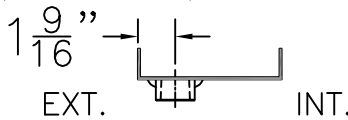

(F) (NO DRAINS).....

< SIDE DRAINS >

(INTERIOR) - 2" LEG ONLY

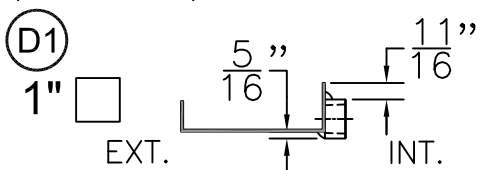

(E1) EXTERIOR 1" DRAIN
NOT AVAILABLE
ON SERIES 4070-T
ARCHE-DUCT

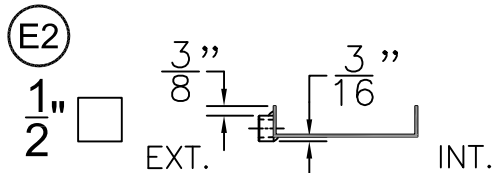
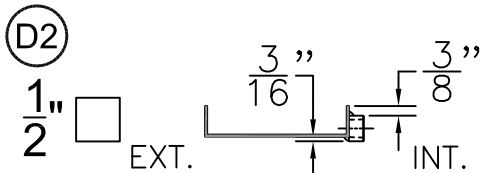

CUSTOMER
SIGNATURE:

DATE: