

COMPANY:

QUOTE #:

ITEM #:

DATE:

DRAIN COUPLINGS TO BE WELDED PER OPTION

PLEASE MAKE SELECTIONS:

>> 1) DRAIN SPACING

- (A) 1) 1" NPT DEFAULT: 8" FROM END; 60" MAX.....
(O.C.)(NON-STAGGERED/STAGGERED)
- 2) 1/2" NPT DEFAULT: 8" FROM END; 36" MAX....
(O.C.)(NON-STAGGERED; 48" MAX(O.C.)(STAGGERED)
- (B) OTHER.....
- 1) FROM END (O.C.): _____
- 2) SPACING (O.C.): _____

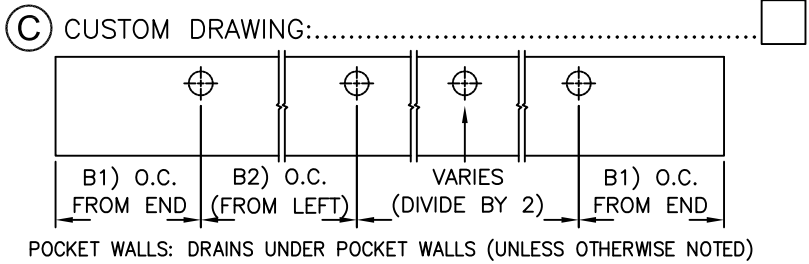
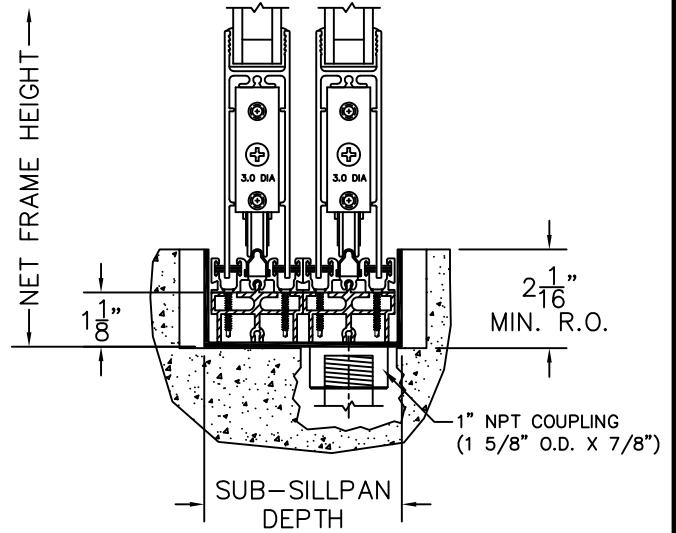
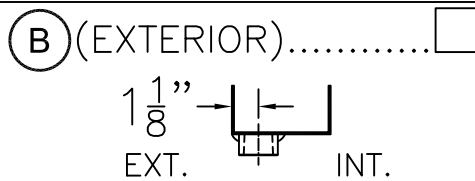
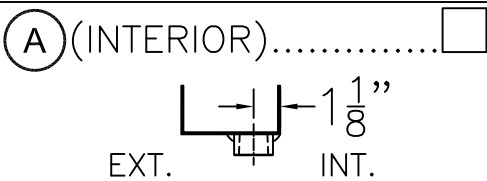

ILLUSTRATION ONLY
(TWO TRACK 1"
BOTTOM DRAIN SHOWN)



>> 2) DRAIN COUPLING LOCATIONS (OPTIONS)

< BOTTOM DRAINS >



< CUSTOM >

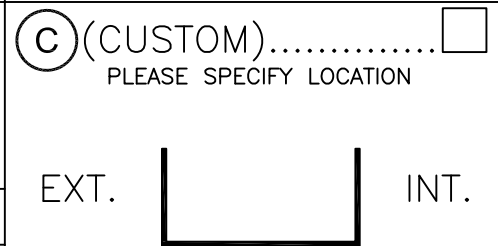

< SIDE DRAINS >

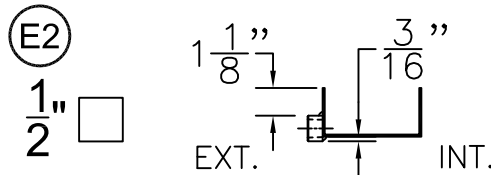
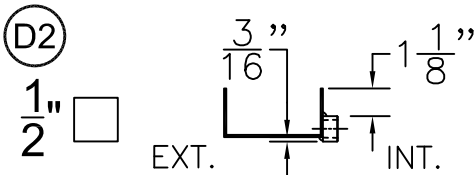
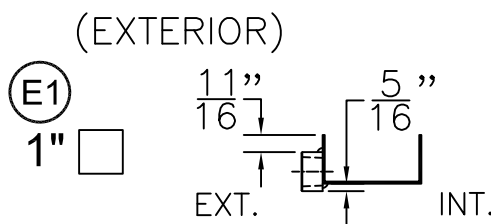
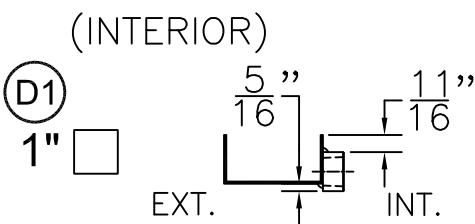

CUSTOMER
SIGNATURE:

DATE: